

RB67 PROFESSIONAL

Mamiya

電動ロールフィルムホルダー 6×7
6×7 Power Drive Roll Film Holder
6×7 Power Drive Rollfilmkassette
Dos moteur 6×7

120/220

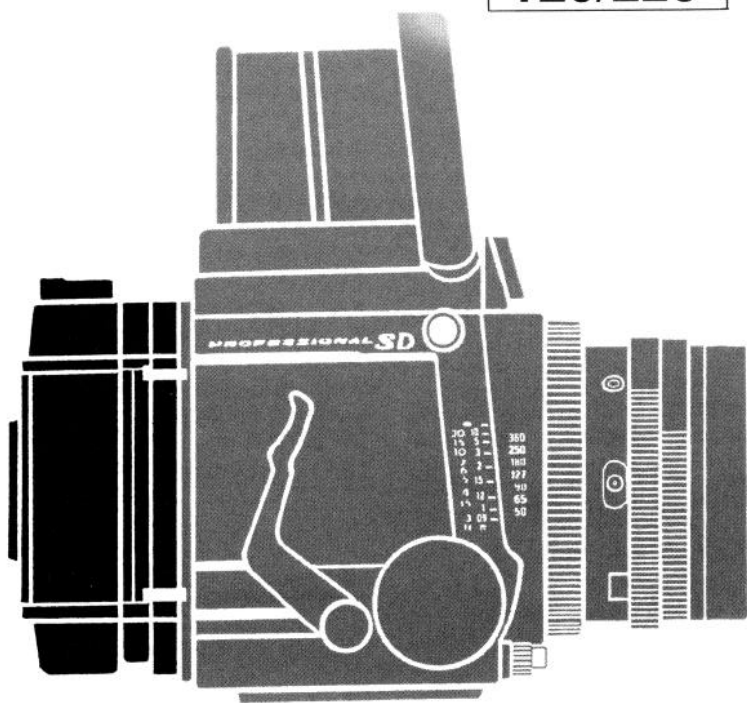

日本語 使用説明書
English Instructions
Deutsch Bedienungsanleitung
Français Mode d'emploi

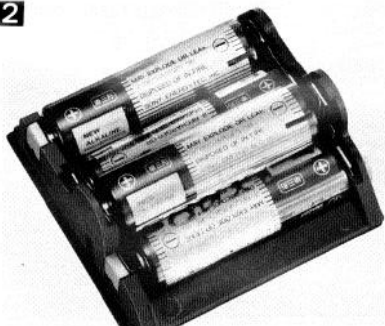
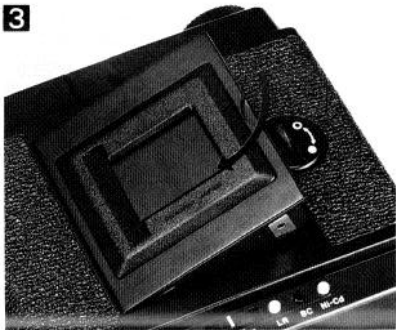
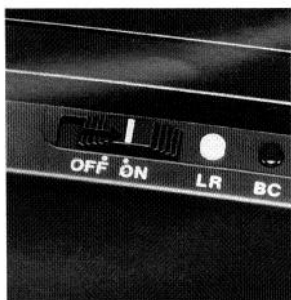
1**2****3****4**

Specifications

Film Type: 120(10 exposures) or 220(20 exposures) roll film selectable

Picture frame: 6×7cm

Film Advance Mechanism: Set with the START button to ON. When the film is set. The loaded film can be advanced either automatically or manually. After shooting the last frame exposure, film advance goes on to wind up completely and stops automatically after ten seconds.

Advance Time: 0.8 sec. per frame.

Additional Features: Built-in double exposure prevention, automatic film wind-stop release, multiple exposure provision, exposure counter with automatic return, automatic drag slide lock and release, battery checker.

Battery: AA-Type alkaline manganese battery or Ni-Cd battery × 4 (for 120 Roll film: approx. 40 rolls).

Dimensions, Weight: 112(height)×124(width)×52(depth)mm, 550g (batteries not included).

Inserting and checking batteries

Batteries used:

1.5V AA-Type alkaline manganese battery or Ni-Cd battery × 4

Turn the battery case lock with a coin 180° in the direction of ◯ mark. Battery case can be removed. (Photo **1**)

Correctly insert the four batteries taking care to match their (+) (-) poles with the corresponding marks on the case. (Photo **2**)

Upon setting the batteries in the case, slidingly insert it into the battery chamber in the direction of the arrowhead. Return the battery case lock in the direction of

● mark to fix the battery case. (Photo **3**) Turn the power switch ON. (Photo **4**) Press Battery Checker to check battery power.

When batteries are set correctly, the BC lamp comes on.

If the BC lamp does not come on, please check Battery polarity.

Then, press the START button and make sure the motor runs correctly. The film advance knob also turns.

CAUTION:

- When the motor drive film holder is not being used, be sure that the power switch is set to OFF. When not using your camera for a long period of time, remove the batteries from the case and store them adequately.
- When using your camera at a place, such as a cold district, where temperature is low, the working parts may remain heavy or the battery performance may deteriorate, causing the film holder to stop working. At this time, immediately turn the power switch OFF.
- Prior to use, be sure to confirm the battery life by pressing the checker buttons. In case the lamps flicker or do not come on, the battery power has depleted. Replace them by new ones.
- Be sure not to use different types of batteries together, nor mix new with old batteries.
- Take care not to incorrectly match (+) (-) of batteries.

5



6

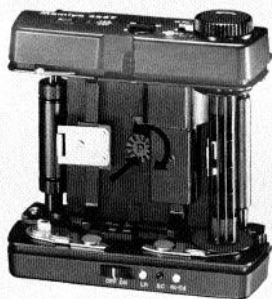

Selecting the pressure plate position

This film holder can use 120 or 220 roll film. In accordance with the film type used, the pressure plate position differs, necessitating the position selecting procedure. As per the following steps, select the pressure plate position so that it aligns with the same numeral (120 or 220) as that of the film type used.

1. Extract the back cover knob while pressing the back cover of the film holder lightly. The back cover opens. (Photo 5)
 2. While pressing the 120/220 pressure plate selector dial in the film insert of the film holder with your fingertips, turn it nearly 180° in the direction of the arrowhead. The pressure plate turns while rising to the surface. (Photo 6 7)
 3. Align the film type used with the film type window of the pressure plate. The numeral display on the film type window also changes automatically over to 120 (white) or 220 (yellow).
 4. As shown, correctly set the pressure plate in position. In the correctly set position, two pins are securely put into the pressure plate positioning guide pin holes. (Photo 8)
- When the numeral 120 (220) appears on the pressure plate window, the exposure counter works with an automatic advance stop mechanism so that the counter stops at 10 (20).

7

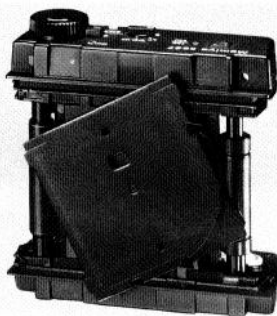

8

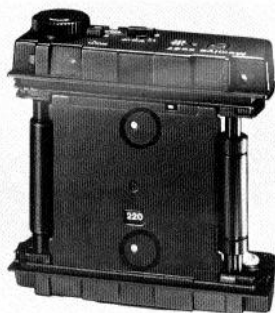

Loading the film holder

When loading the film, avoid direct sunlight, either loading it in the shade or turning your body away from the sun to load it in the shade of your body.

1. While pulling out the left-hand spool release pin of the film insert, fit a new roll of film between the upper and lower film spool studs. Pull the backing paper in the direction of the dotted line and arrow around the stud, over the roller, across the back, over the right-hand roller, and feed it into the take-up spool. When loaded correctly, the inside of the backing paper (black side) will appear outside of the insert back. If it does not, remove the roll of film, turn it upside-down, and reload it. (Photo 9)
2. Insert the tip of the backing paper into the slot of the take-up spool.

In case the backing paper has been pulled excessively, the film may be affected by light or the specified number of exposures may not be achieved. When pulling out the backing paper, therefore, take special care so that it does not exceed the start mark. (Photo 10)
3. Gently wind the film advance knob until the arrow of the backing paper aligns with the insert start mark.

As you gently advance the backing paper, make sure it advances evenly between the spool flanges and does not begin to slant. If it advances unevenly, remove the backing paper from the take-up spool and refeed, starting again. (Photo 11)
4. Place the film insert into the appropriate opening of the outer cassette. Then, close the back cover, and while gently holding it in place, push both of the back cover latches as far as they can go. (Photo 12)

9



11

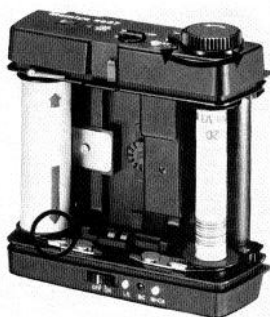

10

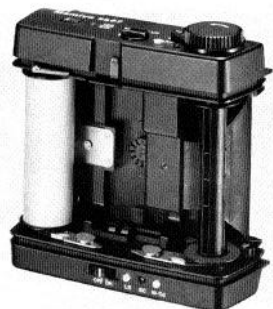

12

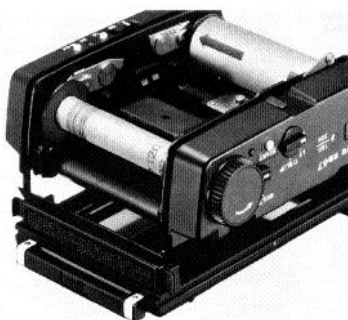

Advancing the film to the first frame

1. Make sure that the multiple exposure lever and selector knob have been set on the white square mark. (Photo 9)
2. When the power switch is turned ON and the START button is pressed, the motor runs and the film is advanced. When "1" appears on the exposure counter, the advance stops automatically, completing the preparation for photographing with the first frame. (Fig. 14)
3. Attach the film holder to the camera body. The memo clip is used to hold your film box covers, keep scratch paper for memo, etc. (Photo 15)

After removing the dark slide and releasing the shutter, the motor driving mechanism works advancing the film, and you are ready for the next photographing. After completing the last exposure, the film and backing paper is completely wound onto the take-up spool automatically.

CAUTION

- During long exposure photographing, if you operate the selector knob of the film holder without releasing the mirror-up, T (time), B (bulb) and shutter setting, the film is automatically advanced to the next frame. Be sure to operate the film holder after releasing the shutter setting.
- For mirror-up photography, T (time) photography, revolving adapter operation, etc. refer to the Instructions for your camera.

Taking photographs

- Depending on the shutter speed, method of photographing, manual operation due to battery power depletion, etc., set the film holder's multiple exposure lever and selector lever as per the table below.

	Shutter Speed	Selector Knob	Multiple Exposure Lever
Motor Drive	1/8 ~ 1/400 sec.	<input type="checkbox"/> (Normal)	<input type="checkbox"/> (Normal)
	1/4 ~ 1 sec.	LT (Long time)	
	T (Time) · B (Bulb) Mirror-up	T/M · UP (Time) (Mirror-up)	
Manual	MULTI (Multiple Exposure)	<input type="checkbox"/> (Normal) LT (Long time)	MULTI (Multiple)
	Full speed	<input type="checkbox"/> (Normal)	<input type="checkbox"/> (Normal)
MULTI (Multiple Exposure)	MULTI (Multiple)		

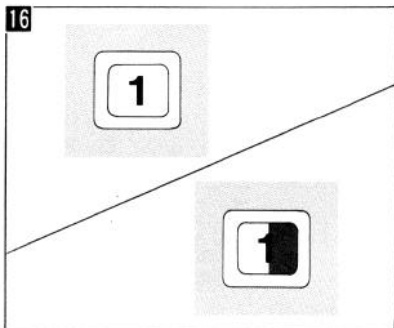
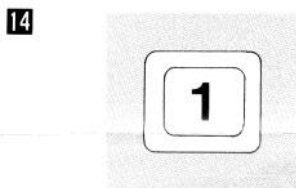
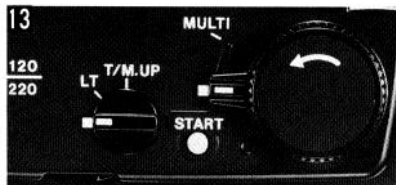

Manual operation

When the film, loaded into the film holder, is completely advanced so that the film advance knob stops, the numeral "1" will appear on the exposure counter. (Be sure to perform this with the dark slide inserted in position.) (Fig. 16)

After removing the dark slide and releasing the shutter, the red warning mark will appear on the exposure counter, indicating that the exposure has been made.

Just when the shutter is released, the film advance stop mechanism is activated, and the film can be advanced to the next frame. When it is advanced, the exposure counter will automatically change and the red mark will disappear.

After an exposure is made, the automatic double exposure prevention mechanism will make it impossible to release the shutter until the film is advanced.

After completing the last exposure, press the cocking lever several times, until the film and backing paper is completely wound onto the take-up spool.

Follow the procedure above even when you must change over to manual operation during photographing, due to battery power depletion, etc.

Unloading the film

Open the back cover of the film holder and remove the film insert. Remove the film, exercising care that the backing paper does not unroll or become loose. In preparation for the next film, remove the empty spool from the film insert, replacing it on the right-hand side so that it will act as the new take-up spool.

When the back cover of the holder is opened, the exposure counter will automatically return to 'S' (Start).

If anything other than 'S' appears in the exposure counter, it indicates that there is film in the holder. To prevent accidental exposure of the film to the light, always check the exposure counter before opening the back cover of the holder.

If you wish to process a roll of film that has been only partially exposed

First remove the holder after inserting the dark slide. Next, when moving the advance stop release lever in the direction of the arrowhead, each time you advance a frame with the film advance knob, the advance stop is released. If this is repeated after each frame advance, the film can be completely wound onto the take-up spool. (Photo 17)

	Film Advance
	Automatic
	Selector knob → Set on LT or □ (Automatic)
	Multiple exposure lever → Set on □
	Film advance knob → Manual

English

Name of Parts

1. Film Type Window
2. Selector Knob
3. Multiple Exposure Lever
4. Film Advance Knob
5. Power Switch
6. Battery Checker (Alkaline Manganese)
7. Battery Checker Lamp
8. Battery Checker
9. Battery Case Lock
10. Back Cover Latch
11. Back Cover
12. Battery Case
13. Memo Clip
14. Dark Slide
15. Dark Slide Release Pin
16. 120/220 Pressure Plate Selector Dial
17. Advance Stop Release Lever
18. START Button
19. Spool Stud
20. Start Mark
21. Take-up Spool
22. Positioning Guide Pin Hole
23. Exposure Counter
24. Pressure Plate
25. Film Type Display Window

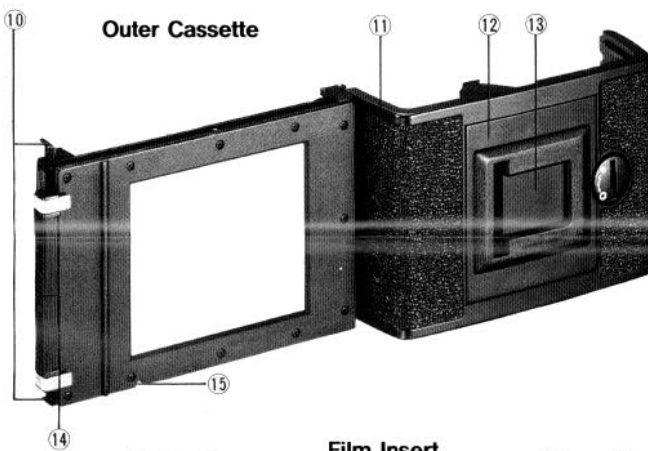
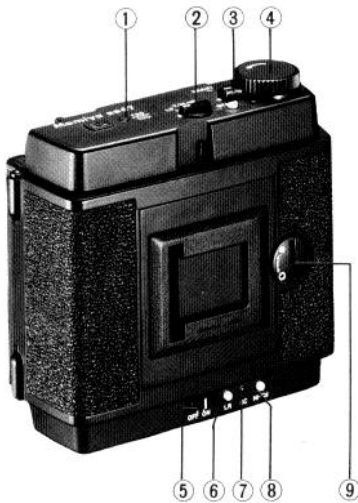

Outer Cassette

Film Insert

